

PILOT VALVES AND ACCESSORIES

29-100 PILOT VALVE (BLACK, 3-WAY)

USED FOR:
PRESSURE REDUCING VALVES (PR) SIZES: 3/4" - 4"

ADJUSTMENT RANGE

SPRING NO.	COLOR	RANGE
54 (STANDARD)	GREEN	10 - 45 m 14 - 65 psi
72	YELLOW	5 - 25 m 8 - 35 psi
65	RED	20 - 60 m 30 - 90 psi

MAX. LINE PRESSURE: 100 m (140 psi)

SPECIFICATIONS

COMPONENT NO.	MATERIAL
1, 5, 6	BRASS
3, 4, 9, 11, 12, 13, 15	PLASTIC
10	NITRILE RUBBER
2, 7, 16, 17	SST
8	SST, NATURAL RUBBER, PLASTIC
14	NATURAL RUBBER

29-100

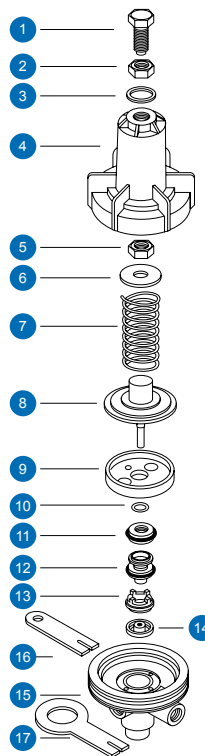

COMPONENTS

1 ADJUSTING BOLT -	10 O-RING
2 LOCKING NUT -	11 SEALING DISC KIT -
3 SPRING IDENTIFICATION RING	12 PORTS SELECTION BODY -
4 BONNET -	13 PLUG SEAT -
5 BONNET NUT -	14 PLUG -
6 SPRING DISC -	15 BODY -
7 SPRING -	16 BRACKET 3/8" -
8 DIAPHRAGM ASSEMBLY -	17 BRACKET 5/8" -
9 DIAPHRAGM BOWL -	

29-110 PILOT VALVE (3-WAY)

USED FOR:
PRESSURE REDUCING VALVE (PR) SIZES: 3/4" - 6"

ADJUSTMENT RANGE

SPRING NO.	COLOR	RANGE
54 (STANDARD)	GREEN	10 - 45 m 14 - 65 psi
65	RED	20 - 60 m 30 - 90 psi
29	-	30 - 130 m 45 - 190 psi

HIGH INLET PRESSURE: 160 m (230 psi)

SPECIFICATIONS

COMPONENT NO.	MATERIAL
1, 5, 6, 15	BRASS
3, 4, 9, 11, 12, 13	PLASTIC
10	NITRILE RUBBER
2, 7, 16, 17	SST
8	SST, NATURAL RUBBER, PLASTIC
14	NATURAL RUBBER

29-110

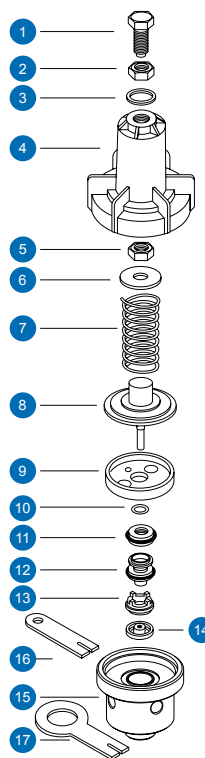

COMPONENTS

1 ADJUSTING BOLT -	10 O-RING
2 LOCKING NUT -	11 SEALING DISC KIT -
3 SPRING IDENTIFICATION RING	12 PORTS SELECTION BODY -
4 BONNET -	13 PLUG SEAT -
5 BONNET NUT -	14 PLUG -
6 SPRING DISC -	15 BODY -
7 SPRING -	16 BRACKET 3/8" -
8 DIAPHRAGM ASSEMBLY -	17 BRACKET 5/8" -
9 DIAPHRAGM BOWL -	

29-200 PILOT VALVE (BLUE, 3-WAY)

USED FOR:

PRESSURE REDUCING VALVE (PR) SIZES: 3/4" - 4"
 PRESSURE SUSTAINING/RELIEF VALVE (PS) SIZES: 3/4" - 4"
 TWO-STAGE OPENING VALVE (TO) SIZES: 3/4" - 4"
 REMOTE CONTROL VALVE (RC) SIZES: 3/4" - 4"

ADJUSTMENT RANGE

SPRING NO.	COLOUR	RANGE
54 (STANDARD)	GREEN	10 - 45 m 14 - 65 psi
72	YELLOW	5 - 25 m 8 - 35 psi
65	RED	20 - 60 m 30 - 90 psi

MAX. LINE PRESSURE: 100 m (140 psi)

SPECIFICATIONS

COMPONENT NO.	MATERIAL
1, 5, 6	BRASS
3, 4, 9, 11	PLASTIC
2, 7	SST
8	BRASS, RUBBER, PLASTIC
10	TEFLON
12, 13	SST

29-200

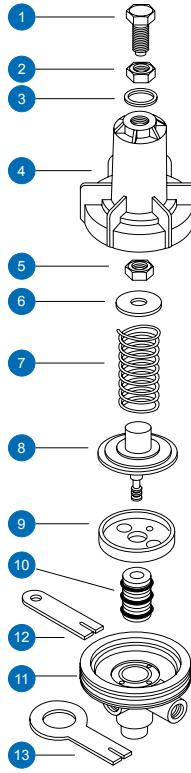

COMPONENTS

- 1 ADJUSTING BOLT
- 2 LOCKING NUT
- 3 SPRING IDENTIFICATION RING
- 4 BONNET
- 5 BONNET NUT
- 6 SPRING DISC
- 7 SPRING
- 8 DIAPHRAGM ASSEMBLY
- 9 DIAPHRAGM BOWL
- 10 PORTS SELECTION BODY
- 11 BODY
- 12 BRACKET- 3/8"
- 13 BRACKET- 5/8"

29-300 DIFFERENTIAL PILOT VALVE (3-WAY)

USED FOR:

FLOW RATE CONTROL VALVE (FR) SIZES: 2" - 4"
 EXCESSIVE FLOW SHUT-OFF VALVE (FE) SIZES: 2" - 4"
 DIFFERENTIAL CONTROL VALVE (DI) SIZES: 2" - 4"

ADJUSTMENT RANGE

(PRESSURE DIFFERENTIAL)

SPRING NO.	COLOUR	RANGE
82 (STANDARD)	—	2 - 5 m 3 - 7 psi
72	YELLOW	6 - 20 m 8 - 30 psi

MAX. LINE PRESSURE: 100 m (140 psi)

SPECIFICATIONS

COMPONENT NO.	MATERIAL
1, 5, 9, 11	PLASTIC
2, 6	BRASS
4	NITRILE RUBBER
3, 7, 12, 13	SST
8	SST, NATURAL RUBBER, PLASTIC
10	BRASS, NITRILE RUBBER

29-300

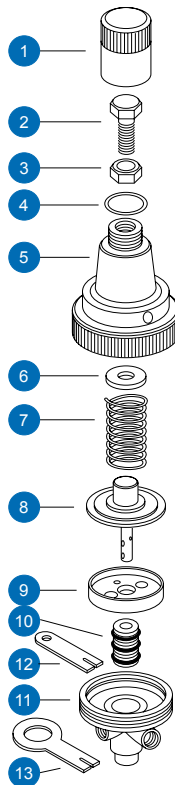

COMPONENTS

- 1 COVER
- 2 ADJUSTING BOLT
- 3 LOCKING NUT
- 4 COVER SEAL (O-RING 6-360)
- 5 BONNET
- 6 SPRING DISC
- 7 SPRING
- 8 DIAPHRAGM ASSEMBLY
- 9 DIAPHRAGM BOWL
- 10 PORTS SELECTION BODY KIT
- 11 BODY
- 12 BRACKET- 3/8"
- 13 BRACKET- 5/8"

31-300 PILOT VALVE (3-WAY)

USED FOR:

PRESSURE REDUCING VALVE (PR) SIZES: 6" - 16"
 PRESSURE SUSTAINING/RELIEF VALVE (PS) SIZES: 6" - 16"
 TWO STAGE OPENING VALVE (TO) SIZES: 6" - 16"

ADJUSTMENT RANGE

SPRING NO.	COLOUR	RANGE
47 (STANDARD)	GREEN	10 - 60 m 14 - 90 psi
42	YELLOW	5 - 30 m 8 - 45 psi
50	RED	20 - 86 m 30 - 130 psi
76	BLACK	70 - 190 m 100 - 285 psi

MAX. LINE PRESSURE: 250 m (360 psi)

SPECIFICATIONS

COMPONENT NO.	MATERIAL
1, 2, 4, 5, 9	BRASS
3	PLASTIC
6, 10, 11	SST
7	SST, NATURAL RUBBER, BRASS
8	NITRILE RUBBER

31-300

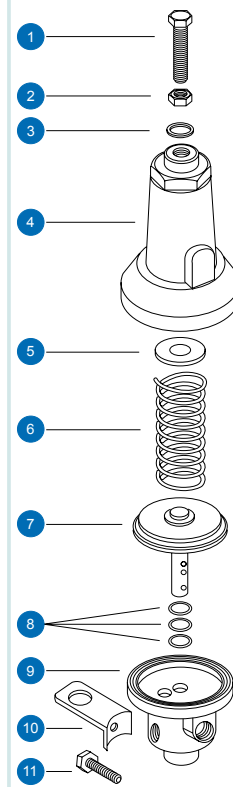

COMPONENTS

1 ADJUSTING BOLT	7 DIAPHRAGM ASSEMBLY
2 LOCKING NUT	8 BODY O-RING
3 SPRING IDENTIFICATION RING	9 BODY
4 BONNET	10 BRACKET
5 SPRING DISC	11 BRACKET BOLT
6 SPRING	

66-200 HYDRAULIC ACCELERATOR RELAY (3-WAY)

USED FOR:

ELECTRICALLY CONTROLLED VALVE (EL) SIZES: 6" - 24"
 ALTITUDE CONTROL VALVE (AL) SIZES: 6" - 24"
 PUMP CONTROL VALVE (BC) SIZES: 3" - 16"
 REMOTE CONTROL VALVE (RC) SIZES: 6" - 16"

OPERATING CONDITIONS

SPRING NO.	RANGE
73 (STANDARD)	15 - 100 m 20 - 140 psi
86	2 - 100 m 3 - 140 psi

MAX. LINE PRESSURE: 250 m (360 psi)

SPECIFICATIONS

COMPONENT NO.	MATERIAL
1, 5, 6, 8, 11	BRASS
2, 9	SST
3	SST, NATURAL RUBBER, BRASS
4	NITRILE RUBBER
7, 10	NATURAL RUBBER

66-200

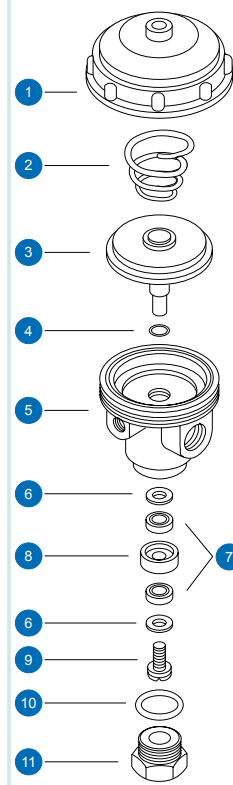

COMPONENTS

1 BONNET	7 SEAL
2 SPRING	8 SEALS HOUSING
3 DIAPHRAGM ASSEMBLY	9 SEAL BOLT
4 BODY O-RING	10 SEAT WASHER
5 BODY	11 SEAT
6 SEAL DISC	

66-300 FAST REACTING PILOT VALVE (3-WAY)

USED FOR:

QUICK RELIEF VALVE (QR) SIZES: 3" - 24"
 SURGE ANTICIPATING VALVE (RE) SIZES: 3" - 24"
 SUSTAINING / RELIEF VALVE (PS) SIZES: 6" - 24"

ADJUSTMENT RANGE

SPRING NO.	COLOUR	RANGE
47 (STANDARD)	GREEN	10 - 60 m 14 - 90 psi
42	YELLOW	5 - 30 m 8 - 45 psi
50	RED	20 - 90 m 30 - 130 psi

MAX. LINE PRESSURE: 250 m (360 psi)

SPECIFICATIONS

COMPONENT NO.	MATERIAL
1, 2, 4, 5, 9, 10, 12	BRASS
3	PLASTIC
6, 13, 15, 16, 17	SST
7	SST, NATURAL RUBBER, BRASS
8, 14	NITRILE RUBBER
11	NATURAL RUBBER

66-300

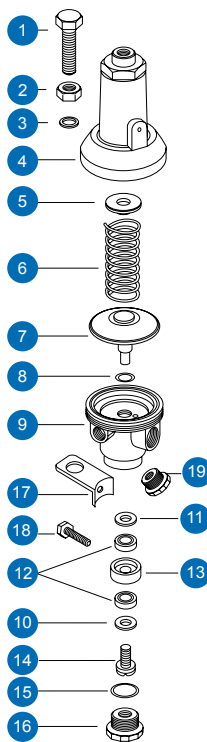

COMPONENTS

1 ADJUSTING BOLT	11 SEAL DISC
2 LOCKING NUT	12 SEAL
3 SPRING IDENTIFICATION RING	13 SEAL HOUSING
4 BONNET	14 SEAL BOLT
5 SPRING DISC	15 SEAT WASHER
6 SPRING	16 SEAT
7 DIAPHRAGM ASSEMBLY	17 BRACKET
8 BODY O-RING	18 BRACKET BOLT
9 BODY	19 PLUG
10 SEAL DISC	

68-200 PILOT VALVE (2-WAY)

USED FOR:

QUICK-RELIEF VALVE (QR) SIZE: 2"

ADJUSTMENT RANGE

(PRESSURE DIFFERENTIAL):

SPRING NO.	COLOUR	RANGE
58 (STANDARD)	GREEN	10 - 90 m 14 - 130 psi
78	YELLOW	5 - 20 m 8 - 30 psi
63	RED	80 - 140 m 115 - 200 psi

MAX. LINE PRESSURE: 250 m (360 psi)

SPECIFICATIONS

COMPONENT NO.	MATERIAL
1, 2, 4, 5, 10, 11, 13, 14	BRASS
3	PLASTIC
6, 9	SST
7	SST, NATURAL RUBBER, BRASS
8, 12	NITRILE RUBBER

68-200

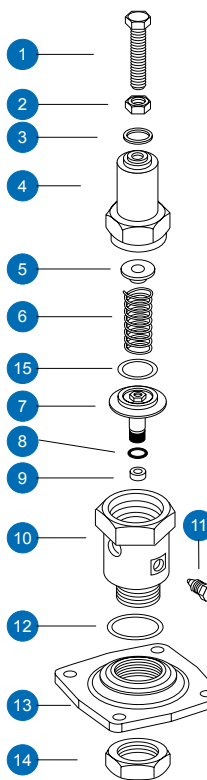

COMPONENTS

1 ADJUSTING BOLT	9 SST SEAT
2 LOCKING NUT	10 BODY
3 SPRING IDENTIFICATION RING	11 NOZZLE BOLT
4 BONNET	12 O-RING
5 SPRING DISC	13 2"-QR BONNET
6 SPRING	14 PILOT LOCKING NUT
7 DIAPHRAGM ASSEMBLY	15 SLIDING WASHER
8 BODY O-RING	

68-410 PILOT VALVE (2-WAY)

USED FOR:
PRESSURE REDUCING VALVE (PR) SIZES: 2" - 6"
HIGH PRESSURE

ADJUSTMENT RANGE

SPRING NO.	COLOUR	RANGE
58 (STANDARD)	GREEN	10 - 110 m 15 - 160 psi
78	YELLOW	5 - 30 m 8 - 45 psi
63	RED	20 - 200 m 30 - 300 psi

MAX. LINE PRESSURE: 250 m (360 psi)

SPECIFICATIONS

COMPONENT NO.	MATERIAL
1, 2, 4, 5, 8, 14	BRASS
3	PLASTIC
6, 10, 13	SST
7, 9	SST, NATURAL RUBBER, BRASS
11, 12	NITRILE RUBBER

NEW

68-410

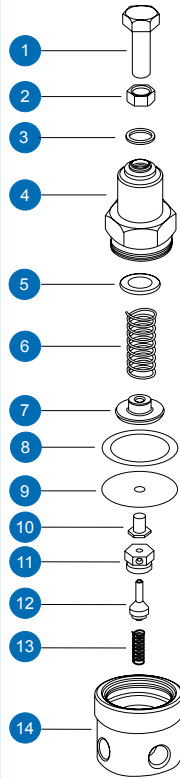

COMPONENTS

1 ADJUSTING BOLT	8 BONNET WASHER
2 LOCKING NUT	9 DIAPHRAGM
3 SPRING IDENTIFICATION RING	10 DIAPHRAGM BOTTOM LOCK
4 BONNET	11 NOZZLE
5 SPRING DISC	12 SEAL ASSEMBLY
6 SPRING	13 BALANCING SPRING
7 DIAPHRAGM TOP DISK	14 BODY

68-420 PILOT VALVE (2-WAY)

USED FOR:
PRESSURE REDUCING VALVE (PR) SIZES: ¼" - 6"

ADJUSTMENT RANGE

SPRING NO.	RANGE
20	4 - 120 m 6 - 175 psi

MAX. LINE PRESSURE: 250 m (360 psi)

SPECIFICATIONS

COMPONENT NO.	MATERIAL
1, 2, 4, 5, 8, 10	BRASS
3, 7, 14	PLASTIC
6, 11, 13	SST
12	SST, NATURAL RUBBER, BRASS
9	NITRILE RUBBER

NEW

68-420

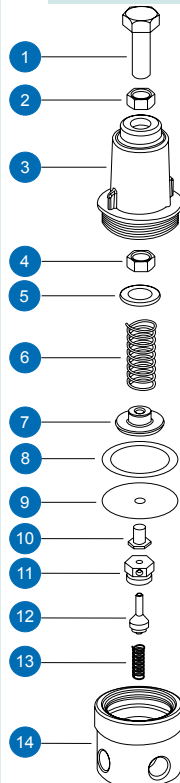

COMPONENTS

1 ADJUSTING BOLT	8 BONNET WASHER
2 LOCKING NUT	9 DIAPHRAGM
3 BONNET	10 DIAPHRAGM BOTTOM LOCK
4 BONNET NUT	11 NOZZLE
5 SPRING DISC	12 SEAL ASSEMBLY
6 SPRING	13 BALANCING SPRING
7 DIAPHRAGM TOP DISK	14 BODY

68-500 PILOT VALVE (2-WAY)

USED FOR:
PRESSURE SUSTAINING VALVE (PS) SIZES: 2" - 6"

ADJUSTMENT RANGE

SPRING NO.	COLOUR	RANGE
58 (STANDARD)	GREEN	10 - 90 m 14 - 130 psi
78	YELLOW	5 - 20 psi 8 - 30 psi
63	RED	80 - 140 m 115 - 200 psi

MAX. LINE PRESSURE: 250 m (360 psi)

SPECIFICATIONS

COMPONENT NO.	MATERIAL
1, 2, 4, 5, 9, 11	BRASS
3	PLASTIC
6, 12	SST
7	SST, NATURAL RUBBER, BRASS
8, 10	NITRILE RUBBER

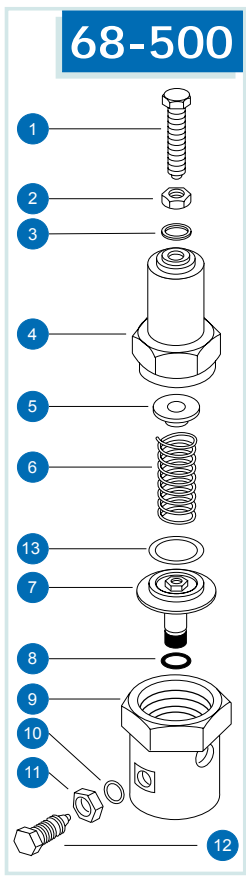

COMPONENTS

1 ADJUSTING BOLT	8 BODY O-RING
2 LOCKING NUT	9 BODY
3 SPRING IDENTIFICATION RING	10 O-RING
4 BONNET	11 LOCKING NUT
5 SPRING DISC	12 NEEDLE BOLT
6 SPRING	13 SLIDING WASHER
7 DIAPHRAGM ASSEMBLY	

68-600 PILOT VALVE (2-WAY)

USED FOR:
PRESSURE REDUCING VALVES (PR) SIZES: 8" - 24"

ADJUSTMENT RANGE

SPRING NO.	COLOUR	RANGE
47 (STANDARD)	GREEN	10 - 150 m 15 - 220 psi
42	YELLOW	5 - 80 m 8 - 110 psi
50	RED	20 - 250 m 30 - 360 psi

MAX. LINE PRESSURE: 250 m (360 psi)

SPECIFICATIONS

COMPONENT NO.	MATERIAL
1, 2, 4, 5, 9, 10, 12, 13	BRASS
3	PLASTIC
6, 14, 15, 16, 18, 19	SST
7	SST, NATURAL RUBBER, BRASS
8, 11	NITRILE RUBBER

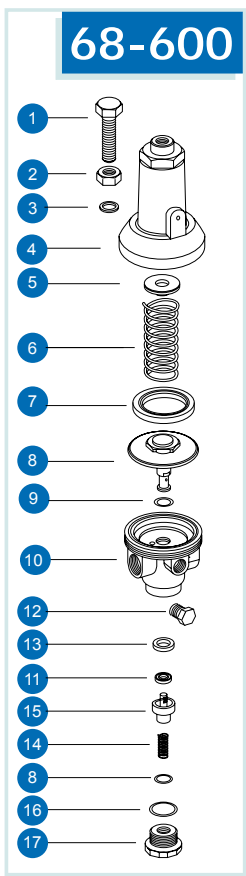

COMPONENTS

1 ADJUSTING BOLT	10 BODY
2 LOCKING NUT	11 SEAL
3 SPRING IDENTIFICATION RING	12 PLUG
4 BONNET	13 SEAL
5 SPRING DISC	14 BALANCING SPRING
6 SPRING	15 SEAL HOUSING
7 BODY ADAPTER	16 PLUG O-RING
8 DIAPHRAGM ASSEMBLY	17 PLUG
9 O-RING	

68-700 PILOT VALVE (2-WAY)

USED FOR:
PRESSURE SUSTAINING VALVES (PS) SIZES: 8" - 24"
HIGH PRESSURE APPLICATIONS

ADJUSTMENT RANGE

SPRING NO.	COLOUR	RANGE
50	RED	20 - 250 m 30 - 360 psi

MAX. LINE PRESSURE: 250 m (360 psi)

SPECIFICATIONS

COMPONENT NO.	MATERIAL
1, 2, 4, 5, 9, 10, 12, 14, 18	BRASS
3	PLASTIC
6, 13, 15, 16, 17	SST
7	SST, NATURAL RUBBER, BRASS
8, 14	NITRILE RUBBER
11	NATURAL RUBBER

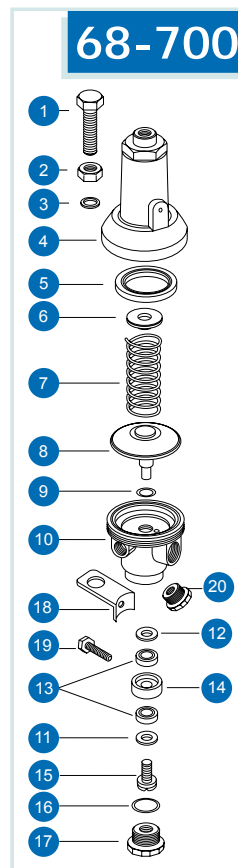

COMPONENTS

1 ADJUSTING BOLT	11 SEAL DISC
2 LOCKING NUT	12 SEAL DISC
3 SPRING IDENTIFICATION RING	13 SEAL
4 BONNET	14 SEAL HOUSING
5 BODY ADAPTER	15 SEAL BOLT
6 SPRING DISC	16 SEAT WASHER
7 SPRING	17 SEAT
8 DIAPHRAGM ASSEMBLY	18 BRACKET
9 BODY O-RING	19 BRACKET BOLT
10 BODY	20 PLUG

70-110 ALTITUDE CONTROL PILOT VALVE (3-WAY)

USED FOR:
ALTITUDE CONTROL (AL) VALVE SIZES 2" - 24"

ADJUSTMENT RANGE

(ELEVATION BELOW WATER LEVEL)

SPRING NO.	COLOUR	RANGE
50 (STANDARD)	RED	3 - 12 m 9 - 36 ft
47	GREEN	1.5 - 5 m 5 - 15 ft
76	BLACK	10 - 50 m 30 - 150 ft

MAX. LINE PRESSURE: 250 m (360 psi)
HIGH-LOW LEVEL DIFFERENTIAL 0.3 - 4 m (1 - 12 feet)

SPECIFICATIONS

COMPONENT NO.	MATERIAL
1, 2, 4, 5, 9, 10, 12, 14, 19, 21, 22	BRASS
3	PLASTIC
6, 7, 16, 17	SST
8, 13	BRONZE
11, 15	NATURAL RUBBER
18, 20	NITRILE RUBBER

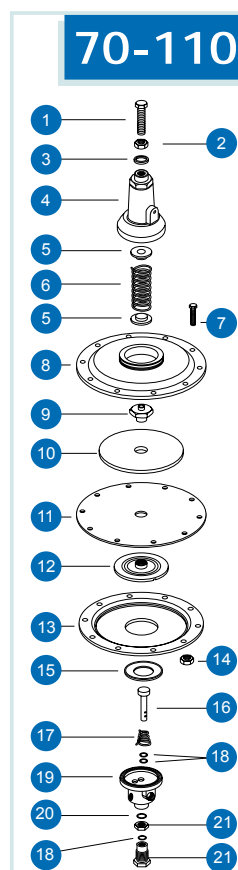

COMPONENTS

1 ADJUSTING BOLT	12 DIAPHRAGM LOWER DISC
2 LOCKING NUT	13 LOWER BOWL
3 SPRING IDENTIFICATION RING	14 BOWL'S NUT
4 BONNET	15 BOWL'S SEAL
5 SPRING DISC	16 PLUNGER
6 SPRING	17 PLUNGER SPRING
7 BOWLS BOLT	18 BODY O-RING
8 UPPER BOWL	19 BODY
9 DIAPHRAGM BOLT	20 SEAT O-RING
10 DIAPHRAGM UPPER DISC	21 SEAT LOCKING NUT
11 DIAPHRAGM	22 SEAT

DIFFERENTIAL FLOAT PILOTS

70-200 ELECTRIC FLOAT

USED FOR:
ELECTRICALLY-ACTIVATED VALVES, ALL SIZES



MODULATING FLOAT PILOTS

70-300 FLOAT PILOT VALVE (PLASTIC, 2-WAY)

USED FOR:
FLOAT CONTROL VALVES (FL), LOW PRESSURE (80 m, 115 psi), ALL SIZES

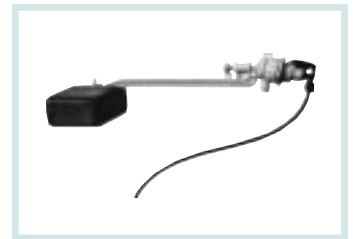

MODULATING FLOAT PILOTS

70-400 FLOAT PILOT VALVE (METAL, 2-WAY)

USED FOR:
FLOAT CONTROL VALVES (FL), HIGH PRESSURE (UP TO 250 m, 360 psi), ALL SIZES

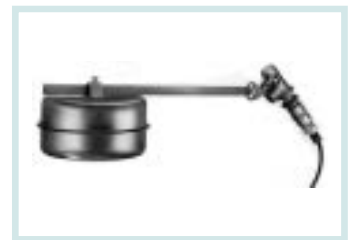

70-550 DIFFERENTIAL FLOAT PILOT VALVE (3-WAY, 4-WAY)

USED FOR:
DIFFERENTIAL LEVEL CONTROL VALVES (DIFL1)
ALL SIZES

MAX. LINE PRESSURE: 250 m (360 psi)
HIGH-LOW LEVEL DIFFERENTIAL: 5 - 40 cm (ONE ROD)
5 - 100 cm (TWO RODS)
5 - 160 cm (THREE RODS)

COMPONENTS

- 1 HUB NUT
- 2 VALVE BOLT
- 3 SUSPENSION PLATE
- 4 HUB
- 5 VALVE
- 6 BALANCING WEIGHT
- 7 WEIGHT BOLT
- 8 WEIGHT ARM
- 9 LOCKING RING
- 10 VALVE SHAFT BOLT
- 11 VALVE ARM
- 12 PIN
- 13 ROD CONNECTOR
- 14 ROD
- 15 STOPPER
- 16 STOPPER BOLT
- 17 FLOAT

70-550

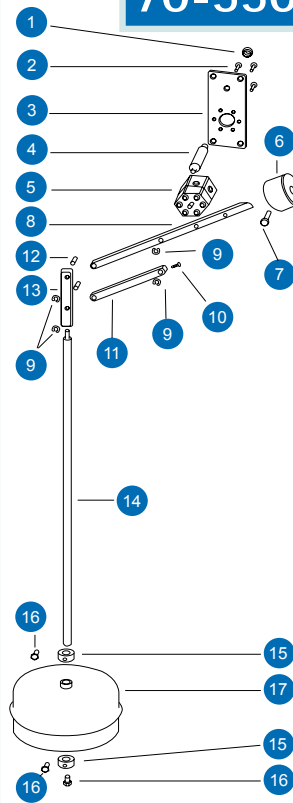

SPECIFICATIONS

COMPONENT NO.	MATERIAL
1, 2, 3, 4, 7, 10, 12, 14, 16, 17	SST
6, 8, 11, 13, 15	BRASS
5	BRASS, SST, RUBBER
9	BRONZE

70-600 DIFFERENTIAL FLOAT PILOT VALVE (3-WAY)

USED FOR:

DIFFERENTIAL LEVEL CONTROL (DIFL 2) VALVES, ALL SIZES

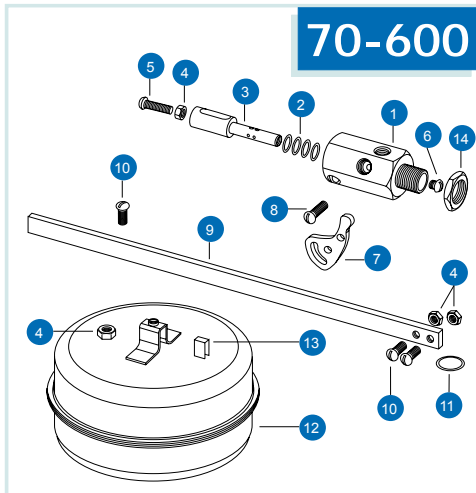

SPECIFICATIONS

COMPONENT NO.	MATERIAL
1, 14	BRASS
3, 4, 5, 6, 7, 8, 9, 10, 11, 12	SST
13	PLASTIC
2	NITRILE RUBBER

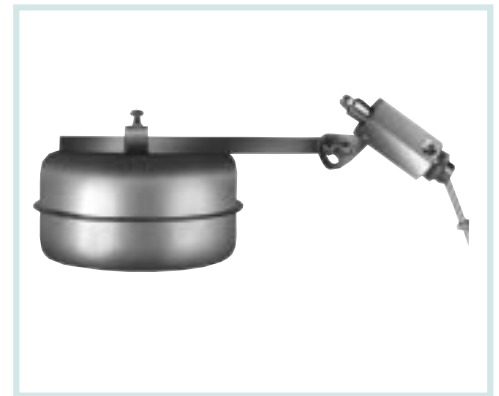

COMPONENTS

1 BODY	8 BOLT
2 O-RING	9 ARM
3 SHAFT	10 BOLT
4 NUT	11 SPRING WASHER
5 BOLT	12 FLOAT
6 BOLT	13 FIXING INSERT
7 CAM	14 NUT

76-200 DIFFERENTIAL PILOT VALVE (3-WAY)

USED FOR:

FLOW RATE CONTROL VALVE (FR) SIZES 6" - 24"
 EXCESSIVE FLOW SHUT-OFF VALVE (FE) SIZES 6" - 24"
 DIFFERENTIAL CONTROL VALVE (DI) SIZES 6" - 24"

ADJUSTMENT RANGE

(PRESSURE DIFFERENTIAL)

SPRING NO.	COLOUR	RANGE
70 (STANDARD)	—	2 - 5 m 3 - 8 psi
69	—	6 - 8 m 9 - 12 psi
47	GREEN	9 - 60 m 13 - 85 psi

MAX. LINE PRESSURE: 250 m (360 psi)

SPECIFICATIONS

COMPONENT NO.	MATERIAL
1, 2, 5, 6, 10	BRASS
4	SYNTHETIC RUBBER
3, 7, 11, 12	SST
8	SST, NATURAL RUBBER, BRASS
9	NITRILE RUBBER

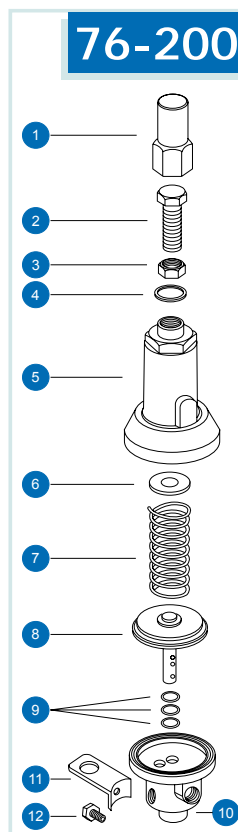

COMPONENTS

1 COVER	7 SPRING
2 ADJUSTING BOLT	8 DIAPHRAGM ASSEMBLY
3 LOCKING NUT	9 BODY O-RING
4 COVER SEAL	10 BODY
5 BONNET	11 BRACKET
6 SPRING DISC	12 BRACKET BOLT

76-600 PILOT VALVE (2-WAY)

USED FOR:

ALTITUDE CONTROL (AL) VALVE SIZES 3" - 24"

FLOW RATE CONTROL (FR) VALVE SIZES 3" - 24"

OPERATING CONDITIONS

ALTITUDE CONTROL

SPRING NO.	COLOUR	RANGE
47	GREEN	0.5 - 5 m 1.5 - 16 ft
50 (STANDARD)	RED	2 - 7 m 6 - 23 ft
76	BLACK	2 - 30 m 6 - 98 ft

MAX. UPSTRAEM PRESSURE: 100 m

FLOW RATE CONTROL

SPRING NO.	COLOUR	RANGE
47	GREEN	0.5 - 5 m 0.8 - 8 psi

MAX. UPSTRAEM PRESSURE: 160 m

SPECIFICATIONS

COMPONENT NO.	MATERIAL
1, 2, 5, 6, 8, 12, 15, 20, 22, 23	BRASS
3, 7, 9, 18, 19, 24, 25, 27, 30, 31	SST
4	SYNTHETIC RUBBER
10, 21, 28, 29	NBR RUBBER
11, 13, 16	BRONZE
14, 17, 26	NR RUBBER

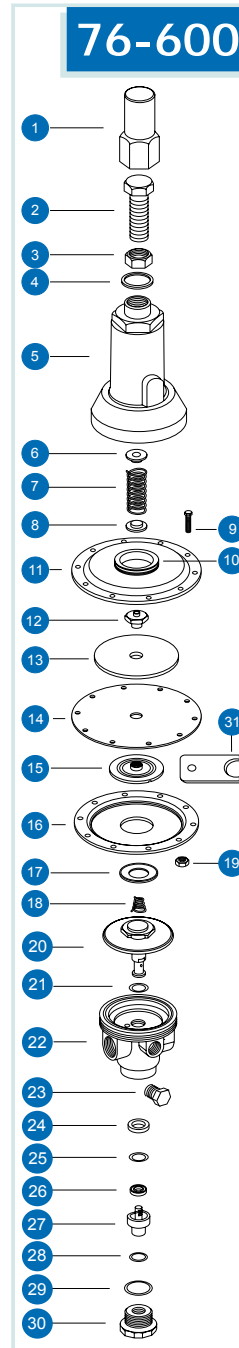

COMPONENTS

- | | |
|-------------------------|-----------------------|
| 1 Cover | 17 Bowl's seal |
| 2 Adjusting bolt | 18 Plunger spring |
| 3 Locking Nut | 19 Nut |
| 4 Cover seal | 20 Diaphragm assembly |
| 5 Bonnet | 21 O-Ring |
| 6 Spring disk | 22 Body |
| 7 Spring | 23 Plug |
| 8 Spring disk | 24 Sealing insert |
| 9 Bowls bolt | 25 Washer |
| 10 O-Ring | 26 Seal |
| 11 Upper bowl | 27 Seal housing |
| 12 Diaphragm bolt | 28 O-Ring |
| 13 Diaphragm upper disk | 29 O-Ring |
| 14 Diaphragm | 30 Plug |
| 15 Diaphragm lower disk | 31 Suspension Bracket |
| 16 Lower bowl | |

"DOROT" SOLENOID VALVE

3-WAY SOLENOID INCLUDES BASE, 2-WAY OPERATOR EXCLUDES BASE

USED FOR:

ELECTRIC VALVES (EL) SIZES: 3/4" - 323"

MAX. OPERATING PRESSURE - 100 m (150 psi)

ELECTRIC DATA

STANDARD COIL - 24 V AC, 50 HZ, INRUSH CURRENT 0.29 A, HOLDING 0.14 A
OTHERS ON REQUEST
ALLOWED VOLTAGE VARIATION ±10%

MODEL NO. 71-NO STANDARD NORMALLY-OPEN, 3-WAY SOLENOID
MODEL NO. 71-BP STANDARD OPERATOR 2-WAY



"BACCARA" SOLENOID VALVE N.O. OR N.C. (3-WAY)

USED FOR:

ELECTRIC VALVES (EL) SIZES: 3" - 24"
 PUMP CONTROL VALVES (BC) SIZES: 3" - 24"

OPERATING CONDITIONS

ORIFICE DIAMETER (mm)	MAX. PRESSURE
1.6 (STANDARD)	150 m / 220 psi
0.8	250 m / 360 psi
2.4	60 m / 90 psi
3.0	40 m / 60 psi

ELECTRIC DATA

STANDARD COIL - 24 VAC, 50 HZ, INRUSH CURRENT 1.08 A, HOLDING 0.6 A
 OTHERS ON REQUEST

ALLOWED VOLTAGE VARIATION +/-10%

MODEL NO. 30-NO STANDARD NORMALLY-OPEN, 3-WAY SOLENOID VALVE
 MODEL NO. 30-NC STANDARD NORMALLY-CLOSED, 3-WAY SOLENOID VALVE
 MODEL NO. 30-BP STANDARD OPERATOR 3-WAY (24 VAC, 50 HZ, 1,6 mm ORIFICE)
 MODEL NO. 30-CO COIL (SPECIFY VOLTAGE, FREQUENCY)



ACCESSORIES

3-WAY CONTROL VALVE

USED FOR:

Manual activation of hydraulic valves.

MODEL NO. 35- $\frac{1}{8}$ "-3 "SAGIV" SY 3 ($\frac{1}{8}$ " CONNECTION)
 MODEL NO. 35- $\frac{1}{4}$ "-3 "SAGIV" SY 3 ($\frac{1}{4}$ " CONNECTION)
 MODEL NO. 35- $\frac{1}{4}$ "-6 "SAGIV" SY 6 (LARGE PASSAGES)



2-WAY BALL VALVE

USED FOR:

Temporary isolation of control devices from pressure line.
 Cancellation of pilot valve controls.

MODEL NO. 34- $\frac{1}{8}$ "
 MODEL NO. 34- $\frac{1}{4}$ "
 MODEL NO. 34- $\frac{1}{2}$ "



PRESSURE SELECTOR TEE

("SHUTTLE VALVE")

USED FOR:

Activation of main valve by two (or more) control devices.

MODEL NO. 12-6-05 (PLASTIC, 6 mm CONNECTIONS)
 MODEL NO. 12-8-05 (PLASTIC, 8 mm CONNECTIONS)
 MODEL NO. 12- $\frac{1}{4}$ -01 (BRASS, $\frac{1}{4}$ " CONNECTIONS)



NEEDLE VALVE

USED FOR:

Restriction of flow in 2-way control systems.
 Restriction of response time in 3-way control systems.

MODEL NO. 34- $\frac{1}{4}$ -NE (BRASS $\frac{1}{4}$ " CONNECTIONS)
 MODEL NO. 34- $\frac{1}{4}$ -NE-1 (SST $\frac{1}{4}$ " CONNECTIONS)



HYDRAULIC RELAY 28-200

USED FOR:

Electric Control (EL). sizes: 6" - 24"
 Remote hydraulic control (RC). sizes: 3" - 24"



SELF-FLUSHING ("FINGER") FILTER

USED FOR:

Filtration of activation water

MODEL NO. 81-1/2-2 - 1/2" MALE, 1/2" FEMALE, BRASS
 MODEL NO. 81-1/4-24 - 1/4" MALE, 1/4" FEMALE, BRASS
 MODEL NO. 81-1/4-58 - 1/4" MALE, 1/8" FEMALE, PLASTIC

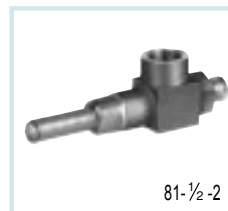

LIMIT SWITCH

USED FOR:

Electric indication of valve position. all sizes.
 Pump Control valve (BC). sizes: 2" - 24"
 Deep Well Control valve (DW). sizes: 2" - 24"

MODEL NO. 40-LS - LIMIT SWITCH
 MODEL NO. 48-LB - BRACKET + BOLTS, NUTS



HYDRAULIC RELAY (3-WAY)

USED FOR:

Remote Controlled Valve (RC). sizes 3/4" - 4"

MODEL NO. 33- 3/8 - "GALIT"



P.E CONTROL TUBE CONNECTORS

USED FOR:

Assembly of control valve. sizes: 3/4" - 4"

AVAILABLE: 6mm OR 8mm O.D. TUBE FITTINGS 1/8" OR 1/4" BSP MALE THREADS

MODEL NO. 36 - ELBOW CONNECTOR
 MODEL NO. 37 - STRAIGHT CONNECTOR
 MODEL NO. 39 - BRANCH T-SHAPE

SPECIFY REQUIRED FITTING BY CAT. NO. - PIPE SIZE - THREAD
 EXAMPLE: 36-6-1/8 IS AN ELBOW CONNECTOR FOR A 6mm PIPE, 1/8" THREAD



PRESSURE CHECK POINT

USED FOR:

Pressure testing valve. sizes: 1 1/2" - 4"

MODEL NO. 32 - 1/4"

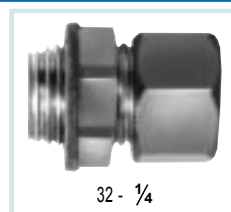

CHECK VALVE

USED FOR:

Assembly of two control sources on the valve.
 Pump Control Valve (BC).

MODEL NO. 21 - 1/2"
 MODEL NO. 31 - 1/8"

